



SIGMA 1868 spol. s r.o.
Jana Sigmunda 79
783 50 Lutín
Tel.: +420 585 651 337
Fax: +420 585 651 339
www.sigmapumpy.com

NO 00 181 | 0108

OPERATING AND INSTALLATION INSTRUCTIONS
FOR

**PORTABLE
PROGRESSIVE CAVITY PUMPS**

EQP





SIGMA 1868
spol. s r.o.

TECHNICAL DATA SHEET
OF PROGRESSIVE CAVITY PUMP
1"-EQP-16-6-GO-372 – RADIAL LIP SEAL
1"-EQP-16-6-GO-373 – MECHANICAL SEAL

NO 00 181.03/806

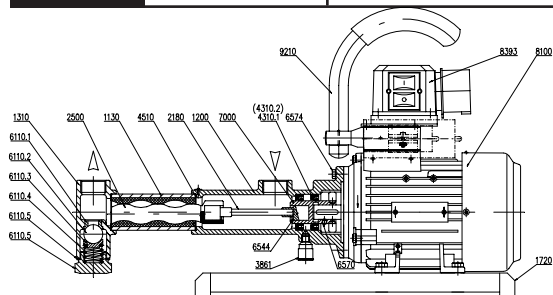

- 6574 - Bolt
- 7000 - Coupling
- 8100 - Electric motor
- 9210 - Handle
- 8393 - Protective switch

- 1130 - Stator
- 1200 - Suction casing
- 1310 - Discharge casing
- 2180 - Connection rod
- 2500 - Helix
- 3861 - Oil cup
- 4310.1 - Wear ring "gufero"
- 4310.2 - Mechanical seal
- 4510 - Packing
- 6110.1 - Seat
- 6110.2 - Ball
- 6110.3 - Backplate
- 6110.4 - Spring
- 6110.5 - Packing
- 6110.6 - Plug
- 6544 - Retaining ring
- 6570 - Bolt

MAIN TECHNICAL DATA

Workmanship version – Single-phase		-372/373	
Name	Symbol	Unit	
Volume flow	Q_v	cm ³ /rev.	16
Firm, guaranteed flow	Q_z	l.s ⁻¹	0.25
Max. speed	n_{max}	min ⁻¹	1,430
Max. delivery head	H_{max}	(m)	60
Max. delivery pressure	$P_{do max}$	MPa	0.6
Gauge pressure in pump suction branch*	$P_{s man}$	MPa	-0.04
Nominal voltage	U	V	230
Cut-off current	I	A	1.5
Nominal current	I	A	8.7
Protection Class	IP 54		
Pump set power input	P_1	KW	0.82
Frequency	f	HZ	50
Noisiness		DB(A)	<70
Max. size of solids in a pumped liquid	$\Phi/1$	mm	2/15
Pump weight	G	kg	24
Max.temperature of a pumped liquid	t	°C	50

Above mentioned values are valid for pumping clean water of temperature up to 25°C, at n_1 , $p_{s man} = -0.04$ MPA

DIMENSIONAL DRAWING

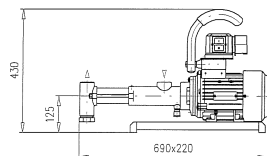

PUMP CHARACTERISTIC

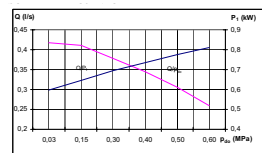

PUMP WIRING DIAGRAM

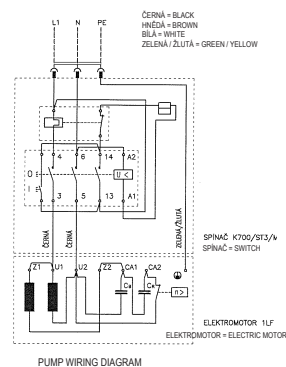

CONTENTS:

- 1.0 GENERAL DATA
 - 2.0 SAFETY
 - 3.0 TRANSPORT, PACKAGING AND STORING
 - 4.0 PRODUCT DESCRIPTION AND ITS ACCESSORIES
 - 5.0 PUTTING THE PUMP SET INTO OPERATION
 - 6.0 OPERATION AND MAINTENANCE
 - 7.0 NOTES PREPARED TO HELP YOU PREVENT PROBLEMS AS WELL AS DEAL WITH THEM
 - 8.0 LIST OF DOCUMENTS
 - 9.0 SPARE PARTS
 - 10.0 WARRANTY
 - 11.0 LIST OF TECHNICAL DATA SHEETS
 - 12.0 DISPOSAL OF WASTE
- DECLARATION OF CONFORMITY
- TECHNICAL DATA SHEETS

Before installation and assembly starting learn these Operating and Service Instructions thoroughly. Simultaneously it is inevitable to observe consistently all valid working, installation and safety rules and regulations.

BASIC REQUIREMENTS ON OPERATION: (see Par. 5.1)

- Pump shall not be started or operated "dry"
- When operating it is necessary to observe the right sense of rotation
- Before every starting-up turn the motor coupling several times (observing all safety rules)
- Pump shall not be used in explosion hazard environments!

1.0 GENERAL DATA

1.1 Validity Scope

These Operating and Service Instructions are in force for portable progressive cavity pump sets EQP : 1" – EQP – 16 – 6 – GO – 072, 073, 172, 173

1.2 Application

Depending on a pumped stuff these pump sets are destined for:

- Watering gardens, irrigation of plots of smaller areas, cars washing, irrigation of park decorative lands, and so on.
- Water withdrawal out of flooded areas, re-pumping underground and waste water, conveying water from rivers, wells, pools, and so on.
- Pumping liquid manure, sewage and polluted liquids containing solids up to max. diameter of 5mm.

When pumping raw sewage containing stuffs tending to winding-around or sticking-on (scraps, paper) there is an actual danger of clogging the pump, hoses or a suction strainer, so it is not recommended to use this pumps without taking measures that can prevent their penetration into the pump.

1.3 Pumped Stuff

For this pump set it is possible to use rubber, quality of which is given in the identification plate being placed on the stator: **rubber quality designation:**

- **NR** .. (mechanical/moulded rubber goods – for transport of service water of pH 6.5 – 12)...
- **NBR** ... (oil-proof, for conveying oil emulsions)
- ...**EPDM** (certificated for potable water, chemicals)

1.3.1 Cleaning liquid

After pumping normal municipal products it is sufficient to use warm water for cleaning. Other cleaning liquids may be used too, (depending on a pumped stuff), however they shall not affect

the pump material and their temperature shall not exceed 50°C for a longer time. However, for a short time (max. 30 minutes) temperature of 70°C is permitted during cleaning process.

1.4 Classification of environment conditions

Pump sets are destined for normal ambient atmosphere.

IT IS NOT POSSIBLE TO USE THEM IN EXPLOSION HAZARD ENVIRONMENT!

1.5 Operation Mode

Continuous operation S1, according to the ČSN 35 000 (IEC 34-1)

1.6 Pump Data Plate

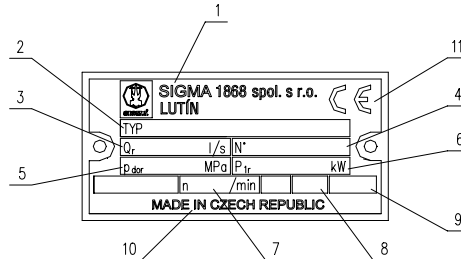

- 1 Manufacturer's trade name and place of business
- 2 Type designation
- 3 Rate of flow
- 4 Serial number
- 5 Delivery pressure
- 6 Pump set power input
- 7 Speed
- 8 Liquid temperature
- 9 Year of production
- 10 Country of origin
- 11 Mark of conformity

	SIGMA 1868 spol. s r.o.	TECHNICAL DATA SHEET OF PROGRESSIVE CAVITY PUMP 1" – EQP-16-6-GO-172 – RADIAL LIP SEAL 1" – EQP-16-6-GO-173 – MECHANICAL SEAL	NO 00 181.02/806

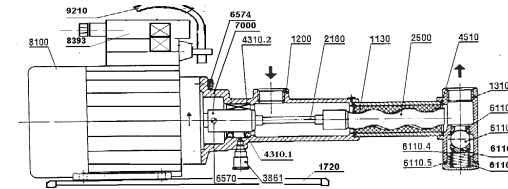

- 6574 - Bolt
- 7000 - Coupling
- 8100 - Electric motor
- 9210 - Handle
- 8393 - Protective switch

- 1130 - Stator
- 1200 - Suction casing
- 1310 - Discharge casing
- 2180 - Connection rod
- 2500 - Helix
- 3861 - Oil cup
- 4310.1 - Wear ring "gufero"
- 4310.2 - Mechanical seal
- 4510 - Packing
- 6110.1 - Seat
- 6110.2 - Ball
- 6110.3 - Backplate
- 6110.4 - Spring
- 6110.5 - Packing
- 6110.6 - Plug
- 6544 - Retaining ring
- 6570 - Bolt

MAIN TECHNICAL DATA

Workmanship version – Single-phase		-172/173	
Name	Symbol	Unit	
Volume flow	Q_n	cm ³ /rev.	16
Firm, guaranteed flow	Q_g	l.s ⁻¹	0.8
Max. speed	n_{max}	min ⁻¹	2,860
Max. delivery head	H_{max}	(m)	60
Max. delivery pressure	$P_{do max}$	MPa	0.6
Gauge pressure in pump suction branch*	$P_{s man}$	MPa	-0.04
Nominal voltage	U	V	230
Cut-off current	I	A	6.7
Nominal current	I	A	6.5
Protection Class	IP 54		
Pump set power input	P_1	KW	1.2
Frequency	f	HZ	50
Noisiness		DB(A)	<70
Max. size of solids in a pumped liquid	$\Phi/1$	mm	2/15
Pump weight	G	kg	21.5
Max. temperature of a pumped liquid	t	°C	50

Above mentioned values are valid for pumping clean water of temperature up to 25°C, at n_r , $p_{s man} = -0.04$ MPA

DIMENSIONAL DRAWING

PUMP CHARACTERISTIC

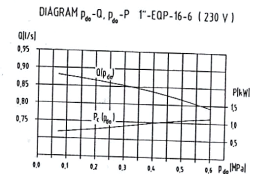

MOTOR WIRING DIAGRAM

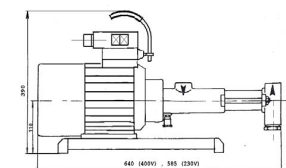
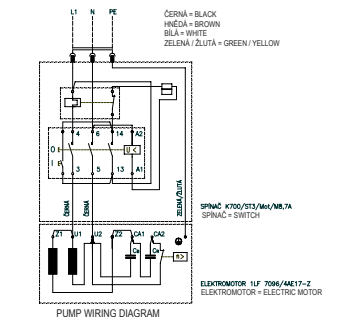



SIGMA 1868
spol. s r.o.

TECHNICAL DATA SHEET
OF PROGRESSIVE CAVITY PUMP
1"-EQP-16-6-GO-072 – RADIAL LIP SEAL
1"-EQP-16-6-GO-073 – MECHANICAL SEAL

NO 00 181.01/806

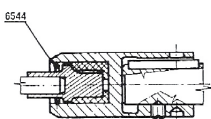
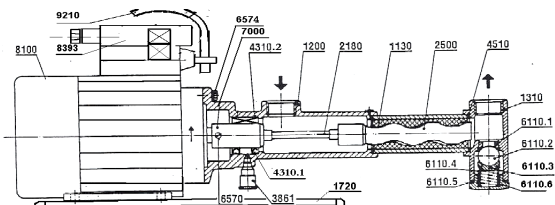

- 7000 -Coupling
- 8100 -Electric motor
- 9210 - Handle
- 8393 -Protective switch

- 1130 -Stator
- 1200 -Suction casing
- 1310 -Discharge casing
- 2180 -Connection rod
- 2500 -Helix
- 3861 -Oil cup
- 4310.1 -Wear ring "gufero"
- 4310.2 -Mechanical seal
- 4510 -Packing
- 6110.1 -Seat
- 6110.2 -Ball
- 6110.3 -Backplate
- 6110.4 -Spring
- 6110.5 -Packing
- 6110.6 -Plug
- 6544 -Retaining ring
- 6570 -Bolt
- 6574 -Bolt

MAIN TECHNICAL DATA

Workmanship version – Single-phase		-172/173	
Name	Symbol	Unit	
Volume flow	Q_n	cm ³ /rev.	16
Firm, guaranteed flow	Q_f	l.s ⁻¹	0.7
Max. speed	n_{max}	min ⁻¹	2,855
Max. delivery head	H_{max}	(m)	60
Max. delivery pressure	$P_{do max}$	MPA	0.6
Gauge pressure in pump suction branch*	$P_{s man}$	MPA	-0.04
Nominal voltage	U	V	400
Cut-off current	I	A	1.7
Nominal current	I	A	1,73
Protection Class	IP 54		
Pump set power input	P_1	KW	1,1
Frequency	f	HZ	50
Noisiness		DB _(A)	<70
Max. size of solids in a pumped liquid	$\Phi/1$	mm	2/15
Pump weight	G	kg	13,8
Max.temperature of a pumped liquid	t	°C	50

Above mentioned values are valid for pumping clean water of temperature up to 25°C, at n_f , $p_{s man} = -0.04$ MPA

DIMENSIONAL DRAWING

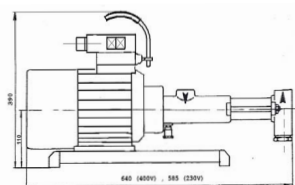

PUMP CHARACTERISTIC

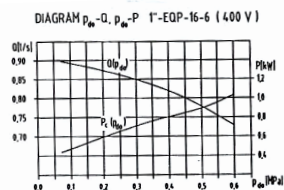

MOTOR WIRING DIAGRAM

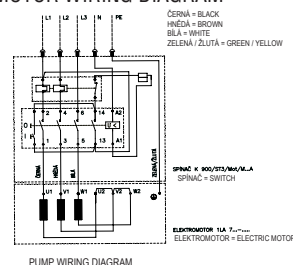

1.6 Pump Model Key – Significance of given designation

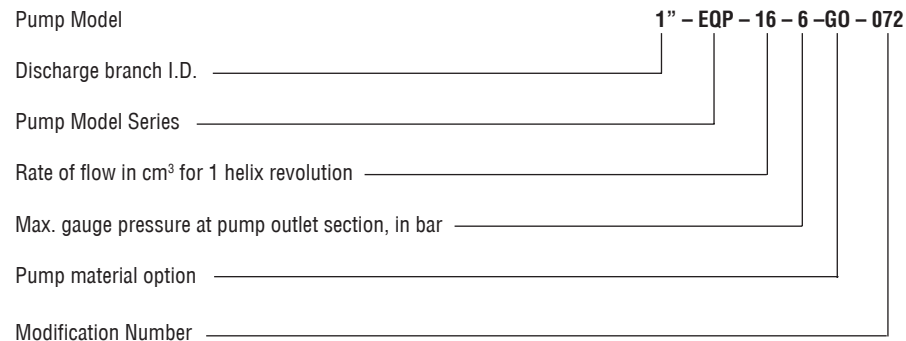

072-3 Three-phase electric motor, radial lip seal "gufero", ... **073-3** Three-phase electric motor, mechanical seal, ... **172-1** single-phase electric motor, radial lip seal "gufero", **173-1** single-phase electric motor.

1.8 Main Technical Data

Main technical data of the model series are given in the Technical Data Sheets.

1.9 Delivery Scope

Pump set may be delivered in the following workmanship versions:

1.9.1 Delivery Scope – Basic workmanship

a) 1"-EQP-16-6-GO-072, 172 (Version with peripheral electrics "S + EP" – Fig. 1 (Hydraulic part sealing with a radial lip seal "gufero"))

- Pump + stand+ handle+ switch with protection + 10m extension cable for mains connection
- Accessories (hook spanner, + wrench 13)
- Spare parts (2x retaining ring-pos. 6544, 2x radial lip seal "gufero"-pos. 4310)
- Service Manual

b) 1-QP-16-6-GO-073, 173 (Version with peripheral electrics "S+EP" – Fig. 1 (Hydraulic part sealing with a mechanical seal))

- Delivery differs from the workmanship version a) only by sealing the hydraulic part with a mechanical seal. Radial lip seal "gufero" – pos. 4310 - is not delivered as a spare part.

1.9.2 Delivery Scope – On Request

a) 1-QP-16-6-GO-072, 172 (Version with peripheral electrics and hydraulic accessories "S + EP + HP") – Fig. 2 (Hydraulic part sealing with a radial lip seal "gufero")

- Pump, accessories and spare parts, according to the Par. 1.9.1a)
- Delivery hydraulic accessories – Pos. 7:
- Elbow L.92.1", ČSN 13 8207
- Screwed quick coupler "GEKA 40113A", for pump
- Hose quick coupler "GEKA 40104"
- Hose 25x12.5m + hose 25x4.5m
- Suction hydraulic accessories
- Elbow L.92.1"
- Screwed quick coupler "GEKA 40113A"...
- Hose quick coupler "GEKA 40104"
- Suction piping 25 – 5m + suction pipe 25/35 – 5m + suction strainer

b) 1-QP-16-6-GO-073, 173 (Version with peripheral electrics and hydraulic accessories "S + EP + HP") – Fig. 2 (Hydraulic part sealing with a mechanical seal)

- Pump, accessories and spare parts, according to the Par. 1.9.1b)
- Delivery hydraulic accessories – pos. 7, according to the Par. 1.9.2.a)
- Suction accessories, according to the Par. 1.9.2.a.

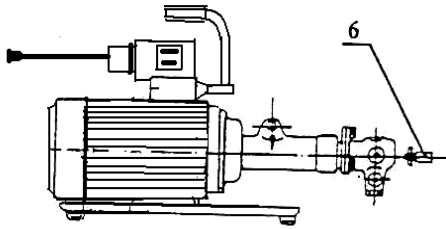

Fig. 1

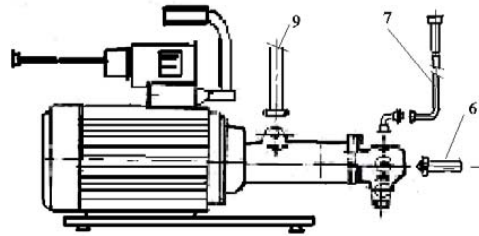

Fig. 2

1.10 Data Needed for Order Application

When ordering it is necessary to give the following data:

- Delivery scope, according to the Par. 1.9. ... + Pump designation according to the Par. 1.7. ... + Number of units ... + Rate of flow
- Required max. working pressure / gauge pressure in the pump delivery section/
- Required suction head
- Sort and properties of a pumped liquid / min. and max. temperature, density, viscosity, chemical properties, and so on/
- Required version of sealing (mechanical seal or radial lip seal "gufero")... pump packaging ..+ Spare parts scope ... + Documentation scope.

1.11 Producer's Address, Factory Authorized Guarantee Repairs and Service Centres

SIGMA 1868 spol. s r.o.
J.Sigmunda 79
783 50 LUTÍN

2.0 SAFETY

These Operating Instructions contain basic instructions that shall be observed within installation, operation and maintenance of these pumps. That is why it is inevitable for competent and responsible workers and service staff to learn these Instructions carefully even before the pump installation and putting

into operation. Keep this Manual handy for future reference at site. **All general safety rules as given in these Operating and Service Instructions shall be observed.**

Safety rules included in these Operating and Service Instructions, breach of which could be a menace to people, are marked with the symbol



Or in cases covering electric safety they are marked with the symbol



Safety rules that shall be considered due to safety working and protection of the pump set shall be provided with the advice

ATTENTION

Safety rules, breach of which could endanger quality of human living environment, are marked with the symbol



Ordinal number of Declaration: 018/B-07

Evidenční číslo prohlášení: 018/B-07

EC DECLARATION OF CONFORMITY ES PROHLÁŠENÍ O SHODĚ

Producer: SIGMA 1868 spol. s r.o.
Výrobce: J. Sigmunda 79, 783 50 Lutín, Czech Republic

Hereby declares that the machinery (assembly) described
Tímto se prohlašuje, že popsané zařízení (sestava):

Product: Portable Progressive Cavity Pump destined for pumping potable and service water, sewages, etc.:
Výrobek: Přenosné vřetenové čerpadlo určené k čerpání pitné i užitkové vody, splašků apod.:

EQP

Complies with the provisions of the machinery directive (MD-98/37/EEC, as amended) and the regulations transposing it into national law (Statutory Order No. 24/2003 of Law Digest, as amended)/ je v souladu s ustanovením směrnice pro strojní zařízení (98/37/EHS, ve znění pozdějších předpisů) a s předpisy, které ji převádějí do vnitrostátních právních předpisů (nařízení vlády č. 24/2003 Sb., ve znění pozdějších předpisů).

It also complies with the provisions of the following European Directives (National Law)/ Rovněž je v souladu s ustanovením těchto evropských směrnic (vnitrostátních předpisů):

LVD-73/23/EEC, as amended (Statutory Order No. 17/2003 of Law Digest., as amended)/ Směrnice 73/23/EHS, ve znění pozdějších předpisů (nařízení vlády č. 17/2003 Sb., ve znění pozdějších předpisů)

EMC-89/336/EEC, as amended (Statutory Order No.616/2006 of Law Digest, as amended) Směrnice 89/336/EHS, ve znění pozdějších předpisů (nařízení vlády č. 616/2006 Sb., ve znění pozdějších předpisů)

It complies with the provisions of the following harmonized technical standards/
Je v souladu s ustanoveními těchto harmonizovaných technických norem:

Tech. standard	Date of issue	Tech. standard	Date of issue
Tech. norma	Datum vydání:	Tech. norma	Datum vydání:
ČSN EN 60 335-2-41, Ed.2	4/04	ČSN EN 60 335-1, Ed.2	5/03
ČSN EN 60 204-1, Ed 2	6/07	ČSN EN ISO 14 847	2/00

It also complies with clauses of the following technical standards/
Je v souladu s ustanoveními těchto technických norem:

ČSN 33 1310	2/90	ČSN 11 7005	9/90
-------------	------	-------------	------

Place and Date of Issue:



Místo a datum vydání:

Name, Function

Jméno, funkce:

Lutín, 20/07/2007
Pavel Majer
Managing Director

SIGMA 1868 spol. s r.o.

  **SIGMA 1868 spol. s r.o.**
místo: Česká republika, Lutín,
ulice Jana Sigmunda č. 79,
PSČ 783 50
Signature/podpis

12.0 DISPOSAL OF WASTE

Directions to disposal of waste generating during life cycle of the pump (by course of § 18, Par. 3 of the Law of Wastes No. 125/1997 of the Code of Law, as amended).

Sort of waste	Code *)	Category	Method of disposal
Paper and/or cardboard packing	15 01 01	0	Utilizable waste – after sorting-out it is necessary to hand it over to an authorized person ensuring taking and purchase of waste
Paper and/or cardboard	20 01 01	0	
Cables	17 04 08	0	
Other scrapped/disabled materials – pump metallic parts (without oil remains)	16 02 05	0	
Other scrapped/disabled parts – non-metallic elements of pumps (e.g. of carbon, carbide, ceramics)	16 02 05	0	Other waste – it is necessary to collect it and hand it over to an operator of a waste dump.
Other scrapped materials – rubber elements of pumps	16 02 05	0	Other waste – it is necessary to collect and hand it over to disposal in an incineration plant
Wood packing	15 01 03	0	
Plastic packing – foil of PE	15 01 02	0	
Edible oils	20 01 08		
Small plastic matters **)	20 01 03	0	
Non-chlorinated motor, gearbox oil and/or lubrication oil	13 02 02	N	Hazardous waste – it is necessary to collect and hand it over to disposal by an authorized person.
Other motor, gearbox and/or lubrication oils	13 02 03	N	
Other solvents and their mixtures with preservative products (except of organic-decomposable)	14 01 03	N	
Products of tar – smooth roofing paper	17 03 03	N	

¹⁾ See the Public Notice No. 337/1997 of the Code of Law, in which the Catalogue of waste was published
 0 – Other waste
 N – Hazardous waste

2) **ATTENTION!** Polytetrafluoroethylene (Teflon, PTFE) shall not be incinerated elsewhere than in a waste incineration plant due to their toxicity!

3) After the pump service life ending, its disposal shall be carried out by handed it over to a person authorized in accordance with the requirements of the Law No. 185/2001 of the Code of Law, as amended.

Zelený bod = GREEN POINT



Re-acceptance and re-usage of waste of packing is guaranteed within the scope of the collective system EKO-KOM by course of requirements of the Law No. 477/2001 of the Code of Law, of packages, as amended. Information on collection, selection and utilization of waste of packing are given at the internet site www.ekokom.cz

3.0 TRANSPORT, PACKAGING AND STORING

3.1 Transport

Pumps are usually transported by rail or by trucks. During transport it is necessary to protect the pump set against shifting to prevent personal accidents and damage of products or transport means.

3.2 Packaging

Packaging of this pump set and spare parts shall be provided in accordance with the customer wish applied in his order. Inlet and outlet branches of pumps are to be blinded to prevent penetration of impurities into the pump interior.

3.3 Storing – Preservation

Pump set or its parts shall be stored in dry and dust-free rooms. As for the pump set temperature during its storing it may range from –8°C to 40°C. It is necessary to apply a protective coat on the stator lining (e.g. glycerine) with pumps destined for storing, and they must be protected from direct solar radiation, from penetration of impurities and chemicals.

Once a year, at least, it is necessary to re-check the stator preservation condition. Maximum storage time for rubber parts is three (3) years since the date of production.

4.0 PRODUCT DESCRIPTION AND ITS ACCESSORIES

4.1 List of Pump Set Main Parts

It is given, including the pump assembly drawing, in the Pump Model Data Sheets.

4.2 Pump Set Technical Description

Pump set consists of the drive part – an electric motor and the pump. Electric motor parameters are given in Technical Data Sheets. In the electric motor, in a terminal board there is a switch with protection and a terminal lead. Extension cable delivered is used for mains connection. This pump consists of a stator with scorched lining (Pos.1130) and the helix (2500). The helix is interconnected with the motor through the connection rod (2180), with rubber joints, with shaft coupling (7000). Suction casing (1200) and discharge casing (1310) are in a required workmanship version equipped with quick

couplers with hose-type connection. Sealing may be realized by means of two shaft rings (4310), or a mechanical seal (4310.2) may be used. Both sealing systems are dimensionally interchangeable. In the delivery space there is a pop safety spring valve consisting of the seat (6110.1), the ball (6110.2) + the ball backplate (6110.3), packing (6110.5) and the plug (6110.6).

The pump set base consists of steel girders with rubber damping feet. Carrying is realized thanks to a tilting bracket.

4.3 Material Option

Metallic details of the hydraulic part coming into contact with a pumped stuff are made of chrome-nickel steel, cast iron, and the stator and the joint are made of rubber resistant to a pumped liquid, according to the Par. 1.3.

4.4 Pump working

While pump running, a helix with a single thread is rotating in the stator cavity. In this way some spaces are created between the helix and the stator cavity into which a pumped stuff is sucked. These spaces filled up with a pumped stuff are shifted thanks to helix motion along the pump longitudinal axis and the stuff is transported from the suction space to the discharge side.

On principle the volume delivered depends only on helix dimensions, speed and the stator dimensions.

4.5 Drive

Pump is driven by electric motor.

CATION

Sense of rotation is marked with an arrow on the pump and it is inevitable to keep this sense of rotation during any operations.

5.0 PUTTING THE PUMP SET INTO OPERATION

Pump set is delivered in complete-assembled state, including electric interconnection of the drive unit terminal board and a protective switch. Accessories are to be mounted on the suction and discharge branches, according to the customer's order. Before putting into operation the operating personal shall proceed as follows:



5.1 Pump Preparation for Operation

Inspect the pump exterior and extension cable that shall be used. If the cable is damaged, **replace it for a new extension lead.**

Pump suction and discharge spaces are to be filled up with clean water or a pumped liquid.

CATION

Pump set cannot be put into operation or be operated “dry”, because the stator rubber lining or pump other parts may be damaged in very short time.



Re-check the pump sense of rotation. It is necessary to keep the adjusted sense of rotation, because the pump set has been designed just for this sense of rotation! Variation of sense of rotation may cause the pump failure. Before the shaft coupling (7000) turning by hand using a wrench make sure whether the pump set has been disconnected from mains! There is an actual danger of injury by an ejected tool due to unwanted starting-up.

Pump set provided with a single-phase electric motor that has been adjusted for the given sense of rotation in the manufacturing plant. As for the pump set with a three-phase electric motor, it is necessary to re-check sense of rotation in this manner:

* Suction branch (closer to the motor) and the discharge branch (further from the motor) shall be filled up with water. Turn the shaft coupling (7000) twice in accordance with the arrow direction, using a spanner hook. This operation shall be carried out whenever the pump set is putting out of operation for a longer time. Insert the cable extension into the motor terminal board connector and the cable plug into the socket outlet, start-up the pump set for a short time using push buttons of protective switches I and 0 (8393) and watch the pump branches with care. * If water is spraying out of the discharge branch the pump set is connected in the right manner; in such case water is spraying out of the suction branch the pump set is not connected correctly, so it is necessary to interchange the phases. After it re-fill water in branches and start the motor for a short time. If the connection is right then the pump set sense of rotation corresponds to the arrows direction marked on the pump suction casing. After making certain of right sense of

6

rotation re-fill the pump set with a pumped water, connect the suction and discharge (make sure whether packing in screwed connection was not damaged) and the pump set is ready-to-start. Immerse the suction pipe in a liquid and put the pump set into operation.



It must be pointed out that the pump set wiring installation including motor phases interchanging should be carried out by a person properly qualified in the electrical engineering. With the pump set any handling (carrying, helix turning-over, disassembly) it is inevitable to disconnect it from mains and prevent it from possibility of its connection to mains by mistake.

6.0 OPERATION AND MAINTENANCE



Monitor the pump set running during its operation, detect any vibration by touch, monitor noisiness by ear and re-check its full run.

After pumping it is necessary to flush the pump set, hoses and other used accessories by clean water or to carry out sanitation, according to the par. 1.3.1. Once a year at least it is necessary to re-fill sufficient grease volume into the space between the radial lip seals, with the pump versions ...-072 or -172. (When pumping water it is recommended to use grease A4). See the Par. 6.2. “Disassembly”.

6.1 Pump Set Stopping

CATION

It is inadmissible to close suction or delivery valves before pump stopping to prevent possible damage of the pump or its motor.

Pump stopping is carried out by interruption of electricity supply for an electric motor by pressing the push button “0” on the protective switch (8393).

6.2 Pump Disassembly

When handling the pump or its drive unit (disassembly, and so on) it is inevitable to make certain of the pump set disconnection from mains to prevent its starting-up by mistake!

9.1 Recommended spare parts

List of recommended spare parts.

1"-EQP-16-6-GO-...		
Position No.	Name	pcs
1130	Complete stator	1
2180	Complete connection shaft	1
2800	Helix	1
4310.1	Radial lip seal “gufero” 30x47x10 ČSN 029401	2
4310.2	Mechanical seal (only versions 073 and 173)	1
4510	Wear ring	2
6110.1	Seat	1
6110.2	Ball 25	1
6110.3	Ball back plate	1
6110.4	Spring 2.5x22.5, 5x38x6.5	1
6110.5	Wear ring 33x45	1
6110.6	Plug	1
6544	Retaining ring	2
7000	Shaft coupling	1

10.0 WARRANTY

Warranty terms for pumps are given in the Certificate of Warranty being delivered together with every pump. During the warranty period the pump dismantling may be carried out solely by the manufacturer or by the authorized service centre with the agreement of the manufacturer.

11.0 LIST OF TECHNICAL DATA SHEETS

1"-EQP-16-6-GO-072, 073 NO 00 181.01/806
 1"-EQP-16-6-GO-172, 173 NO 00 181.02/806
 1"-EQP-16-6-GO-372 NO 00 181.03/806

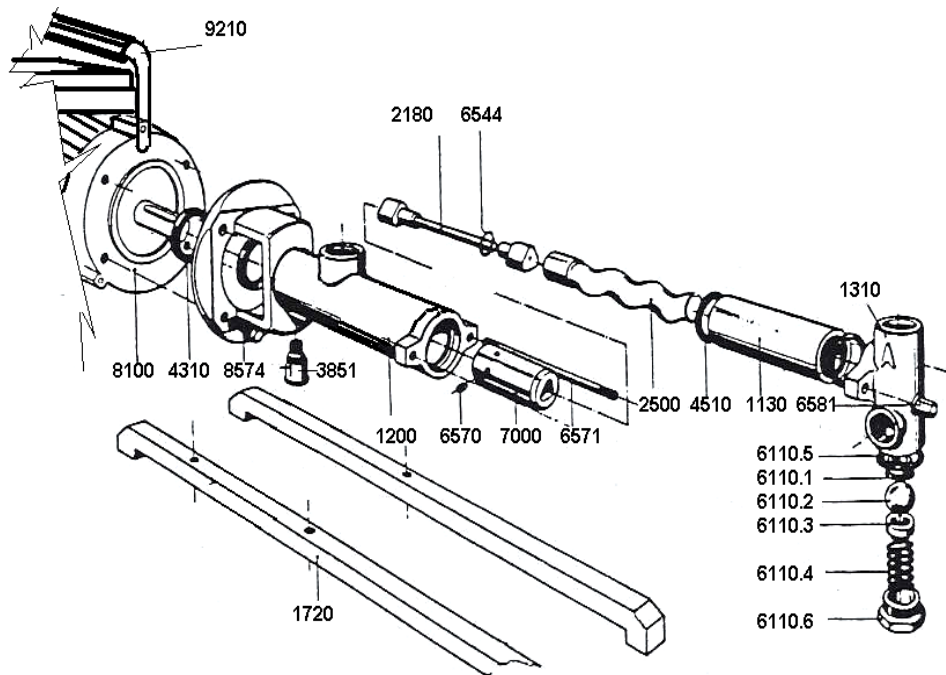

Fig. 5

If it is more advantageous for handling it is also possible to disconnect suction and delivery pipeline.

6.2.1 Pump Disassembly at Replacement of Seal and Rubber Couplings

With replacing rings of radial lip seal "gufero" of the pump workmanship versions ...-072 or ...-172, or with grease re-filling it is necessary to dismount the pump from its drive unit part (by bolts (6574) loosening and forcing the pump hydraulic part off the motor).

Disassembly of joints is to be carried out by removing retaining rings (6544.1), applying a screwdriver. Shaft ring of mechanical seal is to be forced off the shaft coupling (7000). If it is necessary to replace even the shaft coupling (7000), loosen the lock screw (6570) and force the coupling off the electric motor shaft. After some time of operation the end of rubber coupling will grow larger forming a raised edge (Fig. 3). While mounting this raised edge prevents air leakage from the joint cavity and the joint is returned back continuously thanks to compressed air. The raised edge may be removed by grinding-off (using abrasive paper, a smooth file) – Fig. 4 and easy sliding the rubber joint on is allowed like that.

6.2.2 Safety Valve Dismantling

Provided the safety valve should be checked out or it was damaged it should be dismantled as follows:
 - Unscrew the plug (6110.6) with packing (6110.5), remove the spring (6110.4), back plate (6110.3) and the ball (6110.2). After inspection of the ball, seat and spring surfaces re-mount safety valve.

6.2 Assembly Description

Slide the coupling (7000) on the motor shaft and lock it with the bolt (6570). Rubber couplings /couplers of connection rod (2180) are to be inserted into the helix trihedron (2500) and into the coupling (7000) and locked with retaining rings (6544). Two radial lip seal rings "gufero" are to be inserted into the suction casing (1200) – (these are for workmanship versions "072, 172") and between these rings a grease layer is to be applied (or a mechanical seal may be mounted as for the workmanship versions ...-073, .. -173). And now the suction casing may be mounted on the motor with the suction branch leading up. The discharge casing (1310) has been already fitted on. Then some packing e.g. hemp or other packing material should be used. Then silicone grease or glycerine shall be applied on the helix (2500) and this one may be slid on the stator (1130). Before attachment of the discharge casing (1310) in which the safety valve is mounted it is necessary to insert the ring (4510) and retighten the casing using some bolts with washers (6571) with the valve led downwards.

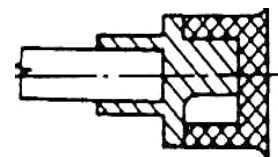

Fig. 3

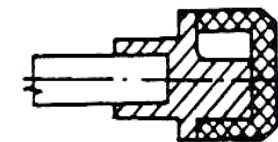

Fig. 4

7.0 NOTES PREPARED TO HELP YOU PREVENT PROBLEMS AS WELL AS DEAL WITH THEM

CAUSE OF PROBLEM							MEASURES	
X							Air is sucked through suction piping	1
	X						Pump was not filled up by a pumped liquid	2
X	X						Suction head is too high	3
	X						Opposite direction of rotation	4
X	X					X	Excessive, too big resistances in suction piping	5
X	X	X	X				Worn-out helix and stator	6
	X						Suction piping is closed - clogged	7
		X	X	X			Helix seizes in stator	8
X	X				X		Change of a pumped stuff viscosity	9
	X			X	X		Too large overhang between the helix and stator	10
				X	X		Pump or electric motor are not fixed sufficiently	11
X		X	X			X	Damage of mech.seal packing rings, radial lip seals "gufero"	12
X		X	X				Drop of motor speed	13
	X	X			X		Damaged motor – it is not working	14
	X	X					Absence of line voltage	15
				X	X		Loose bolts, damaged motor bearing	16
X	X	X		X	X	X	Overloaded pump set (e.g. clogged hose)	17
	X						There are only two phases supplying the power available	18
X	X	X	X				Leakage of safety valve	19

7.1 Some Measures on Defects and Failures Clearing

All detected defects and failures of pumps shall be solely cleared by a service station given in the Certificate of Warranty.



Electrical system installation, including any modifications may be solely carried out by a person properly qualified in electrical engineering, respectively in accordance with standards in operations and with local regulations and rules.

In case of some difficulties showing and finding-out at the pump set start-up and during its operation it is necessary to take measures depending on trouble symptoms that are given in the table of the Section 7 and designed with a numerical code in the table right column:

Numerical Code

Taken Measures

1. Re-check packing, re-tighten pipe joints. Increase suction level of a pumped stuff, remove detected failures.
2. Stop the pump, water it, add and integrate a non-return flap valve or a suction basket into suction piping.
3. Re-set for original values. Increase level of a pumped liquid on the suction side.
4. Stop the pump, change circuitry.
5. Clean the suction strainer and suction piping.
6. Replace damaged details and components for new ones.
7. Stop the pump set. Open fully the valve in suction piping. Clean the suction piping.
8. Stop the pump set, dismantle the helix, detect a cause of defects, replace damaged parts for new ones.
9. Measure viscosity of a pumped liquid, compare it with a value given in the Order, re-set for original, required values.
10. a) Turn the helix in the determined direction of rotation with the motor being disconnected from mains! CAUTION! Prevent the electric motor starting-up during its turning!
b) Dismantle the pump, lubricate both the helix and stator with a suitable liquid and turn the helix over in the stator cavity for several times.
c) Replace the stator.
11. Re-tighten fastening bolts of the pump and electric motor.
12. Replace the radial lip seal "gufero" or mechanical seal.
13. Find out a cause. This problem may be solved according to the measures given in the subparagraphs 8, 9, 10.
14. Repair in the Service Station.
15. Inspection by an authorized person.
16. Re-tighten fastening bolts of the pump and electric motor.
17. Stop the pump set, find out a cause of problem and clear problem. Serious problems shall be solved in the Service Station.
18. Re-check electrical network, if no fault has been found out, turn to the Service Station for help.
19. Dismantle the safety valve, clean, replace a defective component.

8.0 LIST OF DOCUMENTS

Together with the pump set the under-mentioned documents are delivered:

- * Operating instruction for pump + * Service manual for electric motor (provided an electric motor is a part of delivery)
- Certificate of Warranty + * Service manual for a sub-delivery

On request given in an order it is delivered:

- * Pump diagram
- * Dimensional drawing
- * Pump assembly drawing

9.0 SPARE PARTS

When ordering spare parts it is necessary to give:

- * Pump type
- * Pump serial number
- * Number of a part position, according to the list given in the Technical Data Sheet ...
- * Name designation of a part
- * Number of units
- * if possible, it is recommended to give also an Order Number according to which the pump original delivery was realized.
- Pump type / model and its serial number are given on the rating plate being attached to the pump.